



Stage 4 final - Clean by Design

TurboScrew compressors with
exhaust after treatment



TURBOSCREW

First-class performance and efficiency

**C200TS-24 -
C270TS-9**

TurboScrew sets the benchmark for efficiency

CompAir portable compressors

In high-precision construction projects, the efficiency and reliability of compressors is of the utmost importance. CompAir offer a wide range of portable compressors, with a reputation within the industry for the highest quality and reliability, which meet the requirements of numerous mobile compressed air applications.

The C-series from CompAir is constantly evolving and guarantees high energy efficiency, low emissions and many other innovations, which make daily operations and maintenance tasks much easier.

The TurboScrew compressors with their unique bi-turbo technology provide class-leading diesel efficiency, the lowest weight of 3,500kg and super-clean performance in accordance with EC directive 97/68/EG Stage 4 final.

The cleanest diesel technology

The TurboScrew comprises of a QSB-series Cummins engine with SCRT® (Selective Catalytic Reduction Technology) exhaust after treatment system, including oxidation catalytic convertor and diesel particle filter (DPF). This system is capable of removing almost all of the nitrogen oxide emissions from diesel exhaust gases. Our TurboScrew technology complies with the latest emission standard Stage 4, final.



Low pollution and emission-free

C200TS-24 - C270TS-9 DLT 2702

- ▶ **Pressure range**
9 to 24 bar
- ▶ **Volume flow**
20 to 27 m³/min
- ▶ **Engine power**
180 to 224 kW



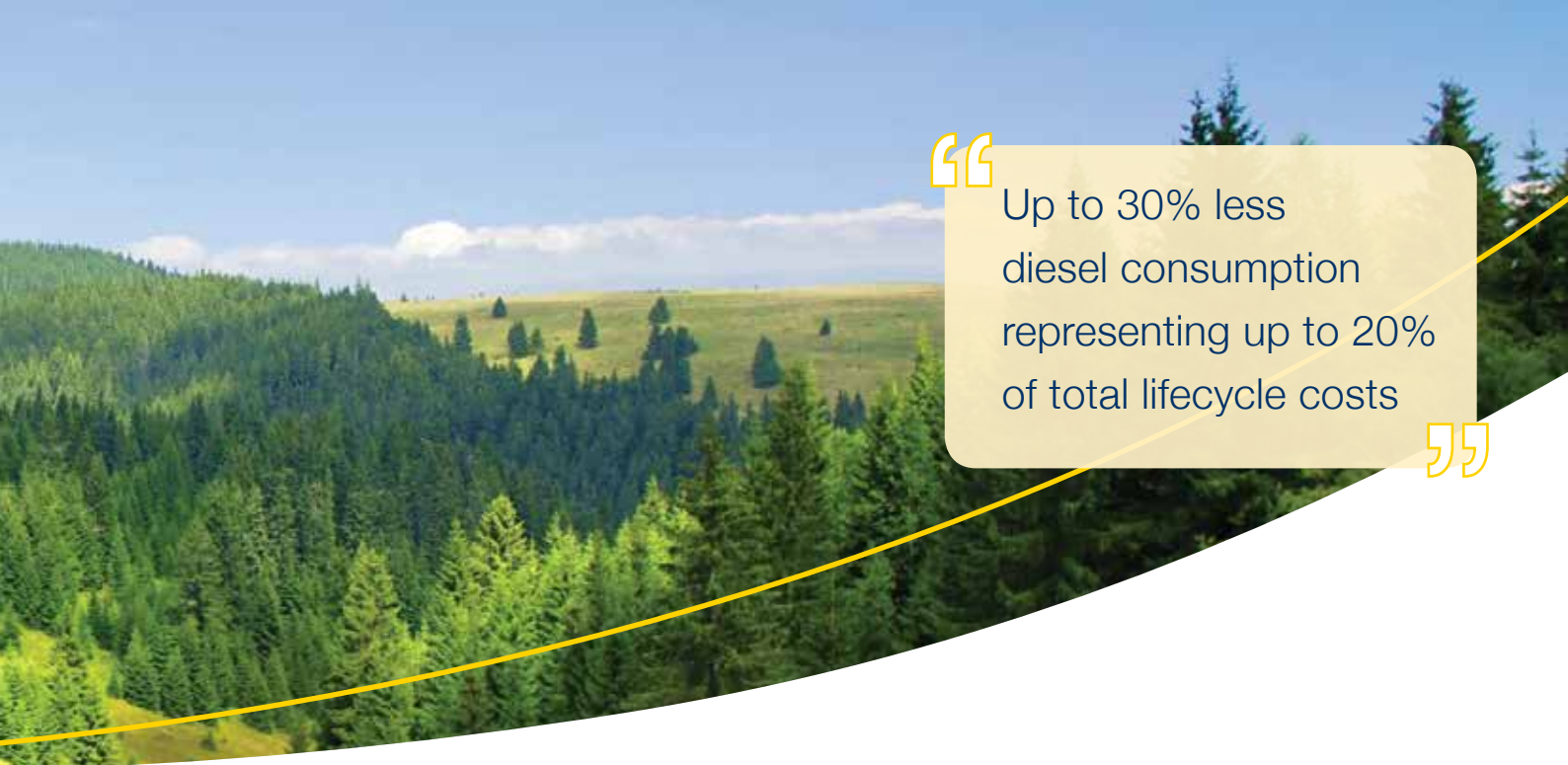

“ Up to 30% less diesel consumption representing up to 20% of total lifecycle costs ”

TurboScrew, the preferred choice

CompAir's patented TurboScrew compression system is a radical new approach to energy conservation. It uses a Cummins turbo assisted engine powering a CompAir screw

compressor unit with the addition of an engine exhaust gas drive turbine, pre-compressing the suction inlet air before it enters the compression chamber.

Energy-saving Bi-Turbo technology

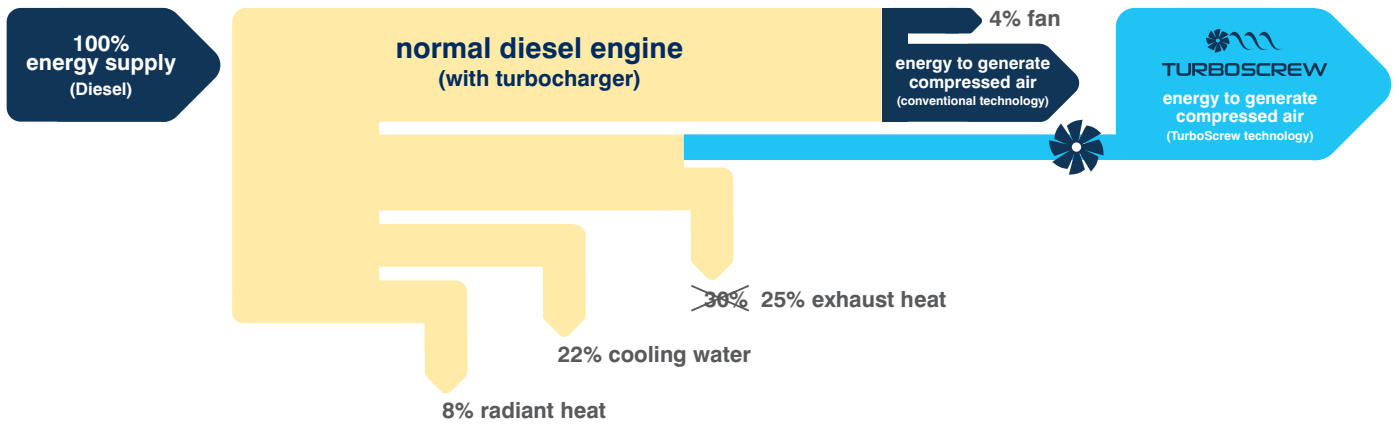

Using the TurboScrew technology, the engine delivers approximately 14% more energy to the compressor than conventional technologies (measured under full load condition).

With average site conditions where the demand varies between idle, part load and full load, the TurboScrew consumes up to 30% less diesel than most of the conventional compressors on the market, resulting in significant cost savings.

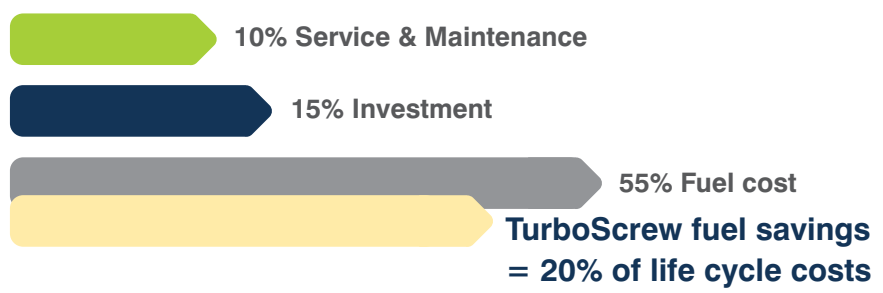

Based on average site running conditions, over lifetime of 10,000 hours, fuel savings of up to 30% can be achieved when compared with equivalent conventional compressors of this output range. This represents up to 20% of total life cycle costs.

Powerful benefits

The TurboScrew quality features

Unrivalled power-to-weight ratio

The TurboScrew features a low overall weight that is up to 2,000kg lighter than comparable compressors, combined with extremely compact dimensions. The compressor can therefore be towed by a vehicle with a maximum towing weight of 3,500kg and is great for getting to hard-to-access sites.

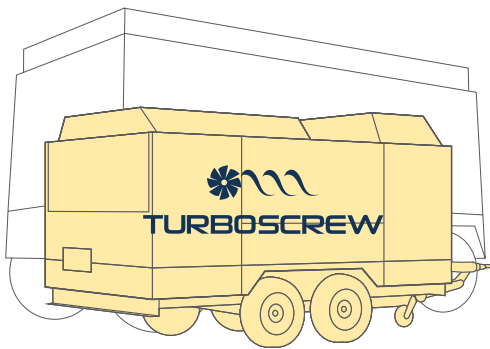

Reliable Cummins QSB 6.7 engine

A robust 6-cylinder turbo-charged and water-cooled diesel engine with an additional integrated turbocharger for the pre-compression of the inlet air of the compressor.

The engine powers a CompAir screw compressor unit with the addition of an engine exhaust gas driven turbine, pre-compressing the inlet air prior to it entering the compression chamber.

Wide regulation range

TurboScrew operates between 1000 and 2400 rpm and adapts precisely to the varying air demand, in turn saving energy.

Easy-to-use compressor controller

Quick and easy operation, status overview, automatic controlled warm-up and cool-down time and Electronic monitoring of engine, compressor and SCRT system.

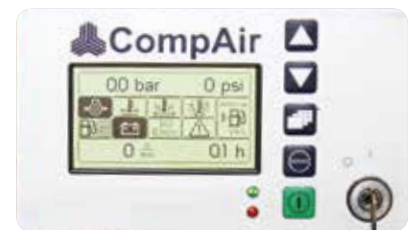

Soft start

Extends the life of the engine by reducing engine stress during start-up and allowing the engine to reach running temperature with the compressor unloaded.

TurboSave

Lubricates the turbo charger in the pre and after run time of the engine and protects it from malfunction.

24 V electrical system

Ensures sufficient power reserves in case of cold starts and the ability for a safe run-up.

Turn signal light

The light comes on in the case of any errors or low diesel / AdBlue levels.

Bolted single sheets

The steel canopy is mass galvanised and electrostatically coated, offering excellent protection against damage and corrosion. With bolted single sheets, exchange is both quick and easy.

Easy access side wing doors

Offering excellent accessibility for easy maintenance.

Tough at work, gentle on the environment

SCRT® – simultaneous reduction of soot particles and nitrogen oxides

The new TurboScrew compressors have been equipped with an award winning SCRT - Selective Catalytic Reduction Technology system which is capable of removing almost all nitrogen oxide emissions from diesel exhaust gases.

How does it work

The proven SMF technology with passive regeneration is used to break down the soot that collects in the SMF. The oxidation catalytic converter installed upstream converts the nitrogen oxide (NO) in the exhaust gases to nitrogen dioxide (NO₂). The particulate filter then uses this nitrogen dioxide (NO₂) to continuously oxidise and burn off the particulate matter residues (PM or soot oxidation).



The SCR (Selective Catalytic Reduction) system installed downstream now plays its part in reducing the level of nitrogen oxides (NO_x). The urea-based additive (a reduction agent) carried on board and known by the brand name AdBlue® is admixed to the exhaust gases after the diesel particulate filter (SMF). This reduction agent is thermally and catalytically converted to ammonia (NH₃). This ammonia is then used – in combination with the SCR catalytic converter – to convert the nitrogen oxides (NO_x) into the harmless substances nitrogen (N₂) and water (H₂O). In this way the SCR unit reduces the diesel engine's emissions of nitrogen oxides – which pollute the environment and damage people's health – by up to 90 per cent. Together with the particulate filter, the SCR system reduces almost all pollutants in the diesel exhaust gases (SCRT = DPF + SCR system).

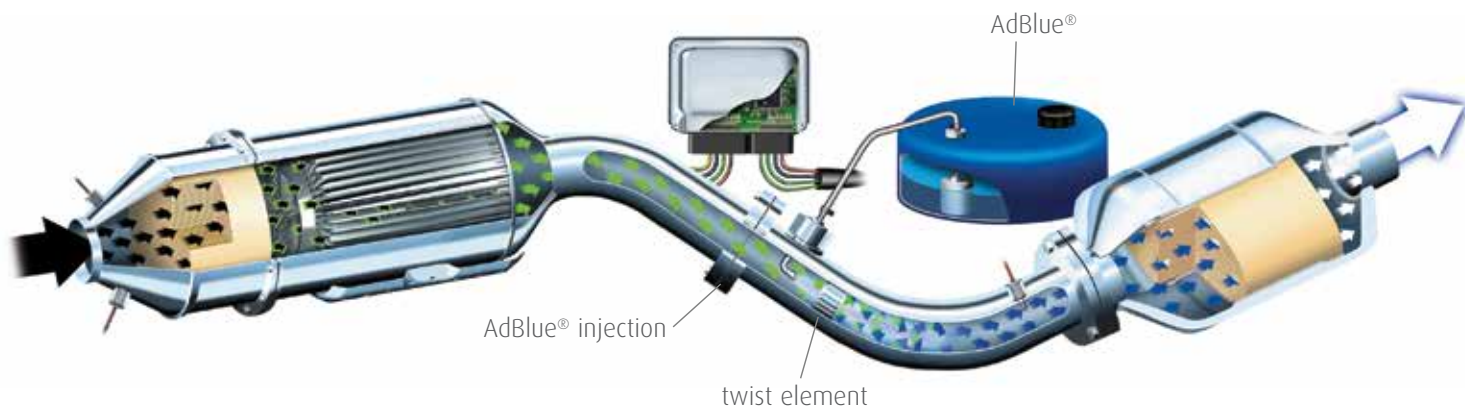

Delivering significant customer benefits



Where it matters

These compressors punch above their weight, providing robust, tough and reliable operation for the most demanding of industry:

- Water well drilling
- Geothermal drilling
- Ship refurbishment
- Oil-barrier
- Building refurbishment
- Bridge refurbishment
- Pneumatic lancing
- Dry ice blasting / sand blasting
- Ground exploration
- Earth loosening work ... and many more.

CompAir genuine spare parts

Genuine CompAir parts and lubricants ensure that reliability and efficiency is maintained at the highest standards. CompAir spare parts and lubricants are distinguished by:

- Long service life, even under harshest conditions
- Minimum losses contributing to energy savings
- High reliability improving operational up-time

“It was a real challenge to complete a project of this scale in the time available,” says Cay Grunau from Hydrotechnik. “It took over six hours to drive the 315-tonne, 55-metre-long monopile around 30 metres down into the seabed. This meant that the CompAir compressors ran continuously for around 20 hours, but, because of their high fuel efficiency, we were still able to save about 2000 litres of fuel on this particular project compared with similar compressors.”



Scan the QR code to read the case study.

AirPlus

- Towing eye: car to ball, 76mm, DIN 40mm
- Adapter 13/7 pole for connection cable to the towing vehicle
- Without chassis
- Skid mounted, with forklift receptacles
- Preheating that allows the reliable start of the engine in ambient temperatures down to -25°C
- Special paint colour and labelling to customer specification

For models up to 14 bar:

- Aftercooler with reheater
- Filtration

Technical Data

C200TS-24 to C270TS-9

[mm]

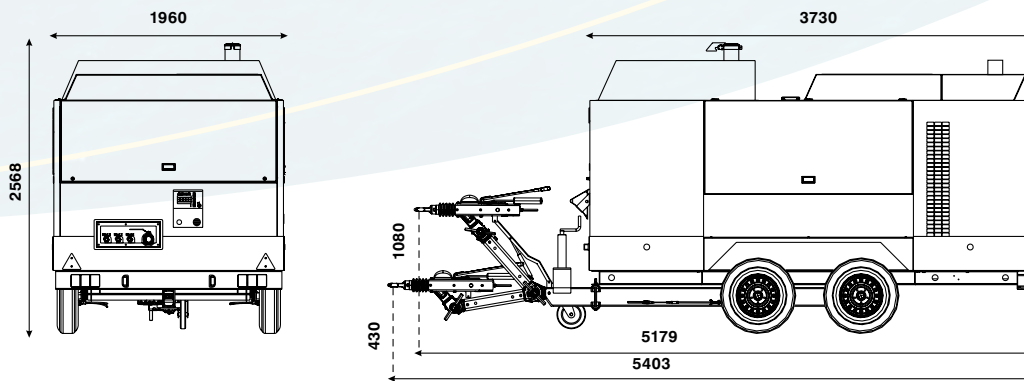

Skid Mount

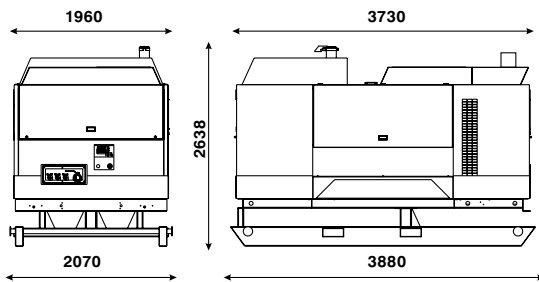

Base Mount

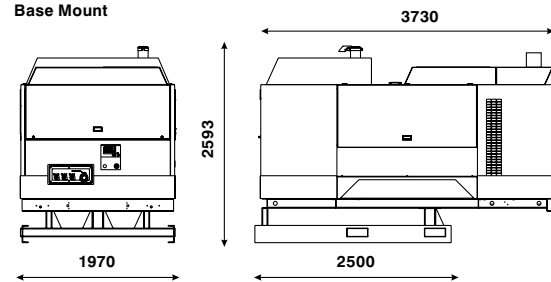

Product range	DLT 2702								DLT 2702 HP			
Type	C200TS-14	C210TS-12	C220TS-10	C230TS-9	C240TS-14	C250TS-12	C260TS-10	C270TS-9	C200TS-24	C210TS-21	C230TS-17	
Operational data												
Volume flow ¹⁾	m ³ /min	20	21	22	23	24	25	26	27	20	21	23
Operating pressure	bar	14	12	10	9	14	12	10	9	24	21	17
Compressed air outlet		3 x 3/4" and 1 x 2"								1 x 2"		
Engine												
Cummins QSB 6.7												
Installed engine power	kW	180	180	180	180	224	224	224	224	224	224	224
Engine off load speed	1/min	1000	1000	1000	1000	1000	1000	1000	1000	1000	1000	1000
Engine full load speed	1/min	2400	2400	2400	2400	2400	2400	2400	2400	2400	2400	2400
Fuel tank capacity	l	350	350	350	350	350	350	350	350	350	350	350
Adblue tank capacity	l	38	38	38	38	38	38	38	38	38	38	38
Operating weight²⁾												
Portable compressor adjustable towbar braked	kg	3450	3450	3450	3450	3490	3490	3490	3490	3490	3490	3490
Skid mount	kg	3545	3545	3545	3545	3585	3585	3585	3585	3585	3585	3585
Base mount	kg	3385	3385	3385	3385	3425	3425	3425	3425	3425	3425	3425
Sound level												
Power sound level ³⁾	dB(A) LWA	100	100	100	100	100	100	100	100	100	100	100
Pressure sound level ⁴⁾	dB(A) LPA	71	71	71	71	71	71	71	71	71	71	71

¹⁾ Acc. to ISO 1217 Ed. 4 2009 Annex D

²⁾ Operating weight without options

³⁾ Legal limiting values of EC directive acc. to 2000/14/EC

⁴⁾ Noise level acc. to PNEUROPN8NTC2.2 at 7m

Global experience – truly local service

With over 200 years of engineering excellence, the CompAir brand offers an extensive range of highly reliable, energy efficient compressors and accessories to suit all applications.

An extensive network of dedicated CompAir sales companies and distributors across all continents provide global expertise with a truly local service, ensuring our advanced technology is backed up with the right support.

As part of the worldwide Gardner Denver operation, CompAir has consistently been at the forefront of compressed air systems development, culminating in some of the most energy efficient and low environmental impact compressors on the market today, helping customers achieve or surpass their sustainability targets.

Portable Compressors (EU & Non EU Range)

C14–C270TS-9

1 to 27 m³/min from 7 to 24 bar

Air Plus offers many variations and options:

- Aftercooler
- Ultra-fine filters
- Integrated generator
- Bunded bottom box
- Hose reel
- Exhaust spark arrestor
- Exhaust gas particulate filter
- Customer colours

Tools

- Chipping Hammers
- Rockdrills
- Pickhammers
- Breakers

Vibration damped tools:

- Rockdrills
- Pickhammers
- Breakers

CompAir policy is one of continuous improvement and we therefore reserve the right to alter specifications and prices without prior notice. All products are sold subject to the Company's conditions of sale.

Accessories:

- Large selection of pointed chisel, slat chisel and spade
- In line lubricator
- Water separator with or without oiler
- Air hoses

Services

- Technical support and advice
- Worldwide service network
- Reliable supply of spare parts
- Individual customer solutions
- Seminars and trainings



www.compair.com sales@compair.com