

Technical sheet :

MI 45 D



	Technical characteristics		Metric
1.1	Manufacturer		Manitou
1.2	Model Name		MI 45 D
1.3	Power source		Diesel
1.4	Operator type		Seated
1.5	Max. capacity	Q	4500 kg
1.6	Load centre of gravity	c	500 mm
1.8	Load distance, centre of drive axle to fork	x	550 mm
1.9	Wheelbase	y	2000 mm
	Weight		
2.1	Service weight		6500 kg
2.2	Weight on front axle (laden) / rear axle (laden)		9625 kg / 1375 kg
2.3	Weight on front axle (Unladen) / rear axle (Unladen)		2820 kg / 3680 kg
	Wheels		
3.1	Tyres type		Pneumatic
3.2	Dimensions of front wheels		300-15-18PR
3.3	Dimensions of rear wheels		7.00-12-12PR
3.5	Number of front wheels / rear wheels		2 / 2
3.5.2	Number of drive wheels		2
3.6	Front wheel gauge	b10	1190 mm
3.7	Rear wheel gauge	b11	1130 mm
	Dimensions		
4.1	Tilt of Mast Forward (deg) / Backward (deg)	α / β	6 / 12
4.12	Height of towing bar (coupling height)	h10	445 mm
4.19	Overall length	l1	4330 mm
4.20	Length to face of forks	l2	3110 mm
4.21	Overall width	b1	1490 mm
4.21	Overall width - Single wheels	b1	1490 mm
4.22	Forks section / width / length	s / e / l	50 mm x 150 mm / 1220 mm
4.23	Fork carriage ISO 2328 (class/form) A/B		3A
4.24	Fork carriage width	b3	1250 mm
4.31	Ground clearance below mast	m1	170 mm
4.32	Ground clearance at centre of wheelbase	m2	230 mm
4.33	Aisle Width for pallets 1000 x 1200 crossways	Ast	4662 mm
4.34	Aisle width for 800 x 1200 pallet lengthways	Ast	4795 mm
4.35	Turning radius	Wa	2800 mm
4.36	Internal turning radius (over tyres)	b13	100 mm
4.7	Height of overhead guard (cabin)	h6	2390 mm
4.8	Seat height/stand height	h7	1370 mm
	Performances		
5.1	Travel speed (laden / unladen)		22 km/h / 24 km/h
5.2	Lifting speed (laden / unladen)		0.46 m/s / 0.48 m/s
5.3	Lowering speed (laden / unladen)		0.50 m/s / 0.50 m/s
5.5	Drawbar pull (Laden / Unladen)		4000 daN / 2000 daN
5.7	Gradeability (laden / unladen)		30 % / 36 %
5.10	Service brake		Hydraulic
	Engine		
7.1	Engine brand / model		Cummins / QSF2.8T4F
7.2	Engine power according to ISO 1585		55 kW
7.3	Rated speed		2600 rpm
7.4	Number of cylinders / Capacity of cylinders		4 - 2800 cm ³
	Miscellaneous		
8.2	Working hydraulic pressure for attachments		160 Bar
8.3	Oil flow rate for attachments		90 l/min
8.4	Measured/guaranteed mean noise level at the ear of the operator		< 84 dB
8.4	Sound level at the driver's ear according to DIN 12 053		84 dB

MI 45 D - Dimensional drawing

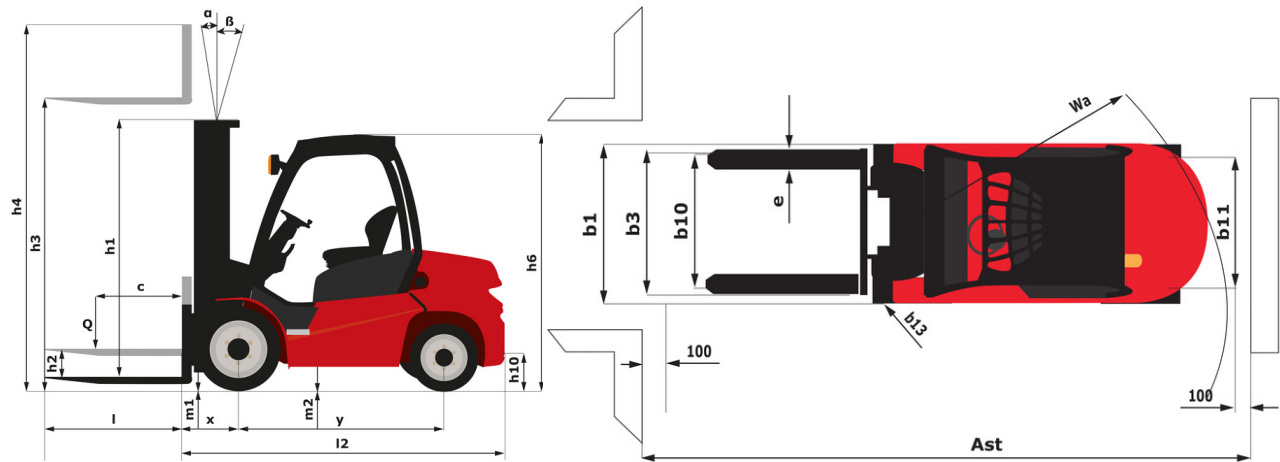

Characteristics of masts and residual capacities

Full Visibility Duplex		FVD 30	FVD 33	FVD 35	FVD 37	FVD 40	FVD 45	FVD 50
h2 - Free lift	mm	160	160	160	160	160	160	160
h1 - Height mast lowered *	mm	2245	2395	2495	2595	2795	3070	3345
h3 - Lifting Height	mm	3000	3300	3500	3700	4000	4500	5000
h4 - Height mast extended *	mm	4170	4470	4670	4870	5170	5670	6170
α / β - Mast inclination (front / rear)	°	6 / 12	6 / 12	6 / 12	6 / 12	6 / 12	6 / 12	6 / 12
Residual capacity without attachment (Industrial load chart)	kg	1500	1500	1500	1500	1500	4100	3700
Residual capacity with integrated side shift (Industrial load chart)	kg	4500	4500	4500	4500	4500	4000	3600
Height at max capacity	mm	3000	3300	3500	3700	4000	4000	4000
Height at max capacity with integrated sideshift	mm	3000	3300	3500	3700	4000	4000	4000

Free Lift Duplex		FLD 30	FLD 33	FLD 35	FLD 37
h2 - Free lift	mm	1364	1514	1614	1714
h1 - Height mast lowered *	mm	2226	2376	2476	2576
h3 - Lifting Height	mm	3000	3300	3500	3700
h4 - Height mast extended *	mm	4170	4470	4670	4870
α / β - Mast inclination (front / rear)	°	6 / 12	6 / 12	6 / 12	6 / 12
Residual capacity without attachment (Industrial load chart)	kg	4500	4500	4500	4500
Residual capacity with integrated side shift (Industrial load chart)	kg	4500	4500	4500	4500
Height at max capacity	mm	3000	3300	3500	3700
Height at max capacity with integrated sideshift	mm	3000	3300	3500	3700

Free Lift Triplex		FLT 40	FLT 43	FLT 45	FLT 47	FLT 50	FLT 55	FLT 60
h2 - Free lift	mm	1229	1329	1395	1459	1559	1724	1939
h1 - Height mast lowered *	mm	2080	2180	2248	2310	2410	2575	2790
h3 - Lifting Height	mm	4000	4300	4500	4700	5000	5500	6000
h4 - Height mast extended *	mm	5170	5470	5685	5870	6170	6670	7180
α / β - Mast inclination (front / rear)	°	6 / 12	6 / 6	6 / 6	6 / 6	6 / 6	3 / 6	3 / 6
Residual capacity without attachment (Industrial load chart)	kg	4450	4300	4100	3900	3600	3100	2500
Residual capacity with integrated side shift (Industrial load chart)	kg	4350	4200	4000	3800	3500	3000	2400



Siège Social

430 rue de l'Aubinière - 44150 Ancenis Cedex - France

Tel: +33(0)2 40 09 10 11 - Fax: +33 (0)2 40 09 10 97

www.manitou.com



This brochure describes versions and configuration options for Manitou products which may be fitted with different equipment. The equipment described in this brochure may be standard, optional or not available depending on version. Manitou reserves the right to change the specifications shown and described at any time and without prior warning. The manufacturer is not liable for the specifications given. For more information, contact your Manitou dealer. Non-contractual document. Product descriptions may differ from actual products. List of specifications is not comprehensive. The logos and visual identity of the company are the property of Manitou and may not be used without authorisation. All rights reserved. The photos and diagrams contained in this brochure are provided for information only.

MANITOU BF SA - Limited company with board of directors - Share capital: 39,668,399 euros - 857 802 508 RCS Nantes